

# DONAU



# VILMERS

# DONAU



## Comfort

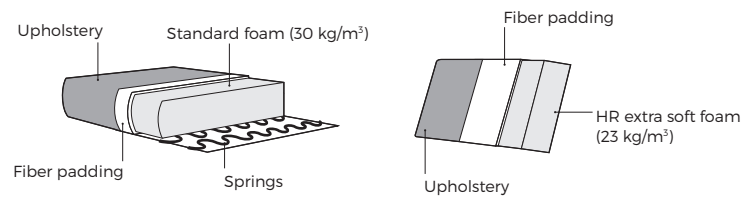

## 1. Upholstery

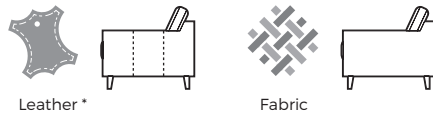

\* Leather upholstery may require more stitches than fabric upholstery.

## 2. Legs

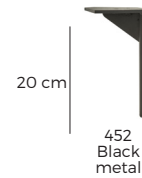

### IMPORTANT:

Upholstered furniture is handmade using soft materials, therefore measurements can vary in all modules by up to **+/-2 cm**.  
Modules and combinations shown in 2D drawings are left-sided. Modules and combinations can be mirrored from left to right.

## Modules

Scale 1:100

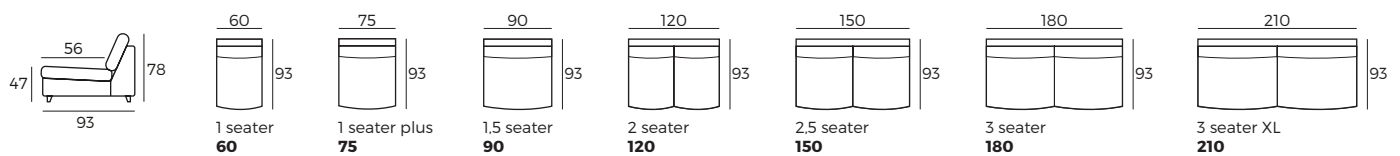

# DONAU

Scale 1:100

## Modules

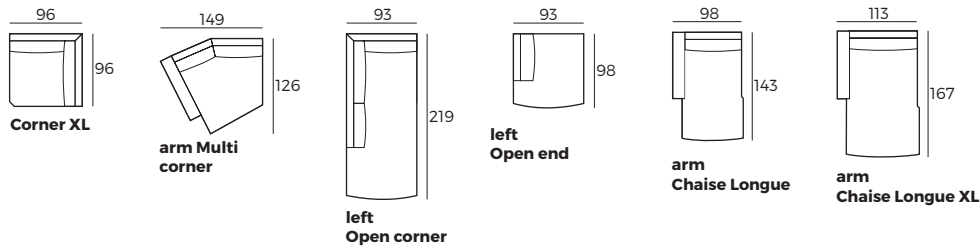

## Modules with armrest

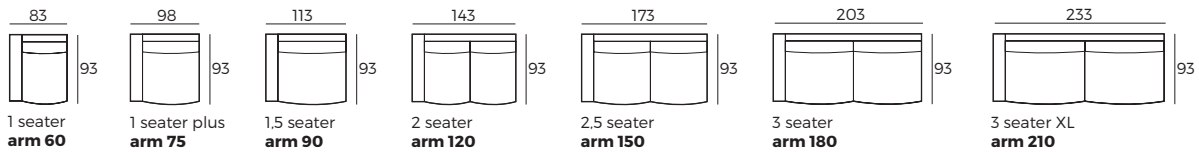

## Combinations

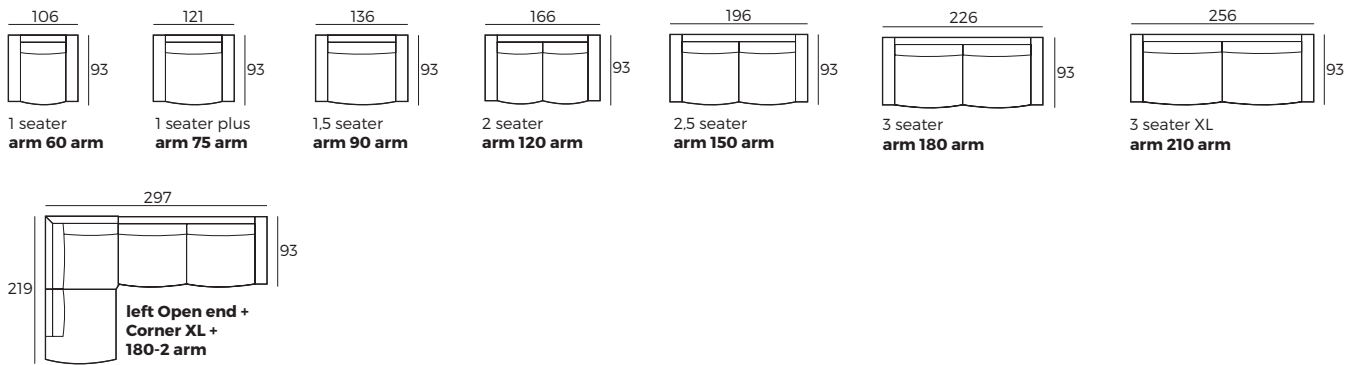

## Accessories

