

THUJA



VILMERS

THUJA



Comfort selection

HARD FOAM

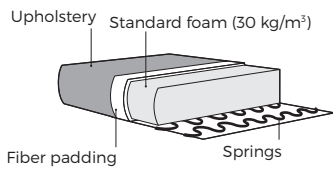

SOFT FOAM

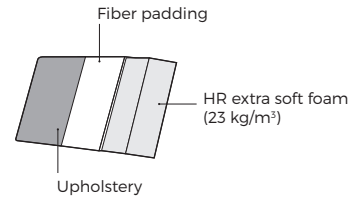
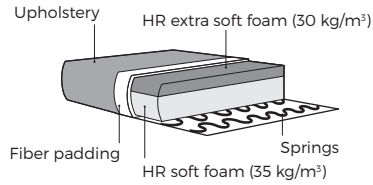

1. Upholstery



Leather*

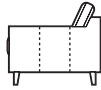

Fabric

* Leather upholstery may require more stitches than fabric upholstery.

2. Legs

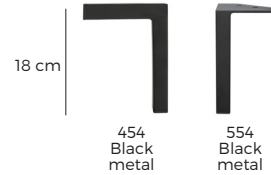

IMPORTANT:

Upholstered furniture is handmade using soft materials, therefore measurements can vary in all modules by up to **+/-2 cm**. Modules and combinations shown in 2D drawings are left-sided. Modules and combinations can be mirrored from left to right.

Modules

Scale 1:100

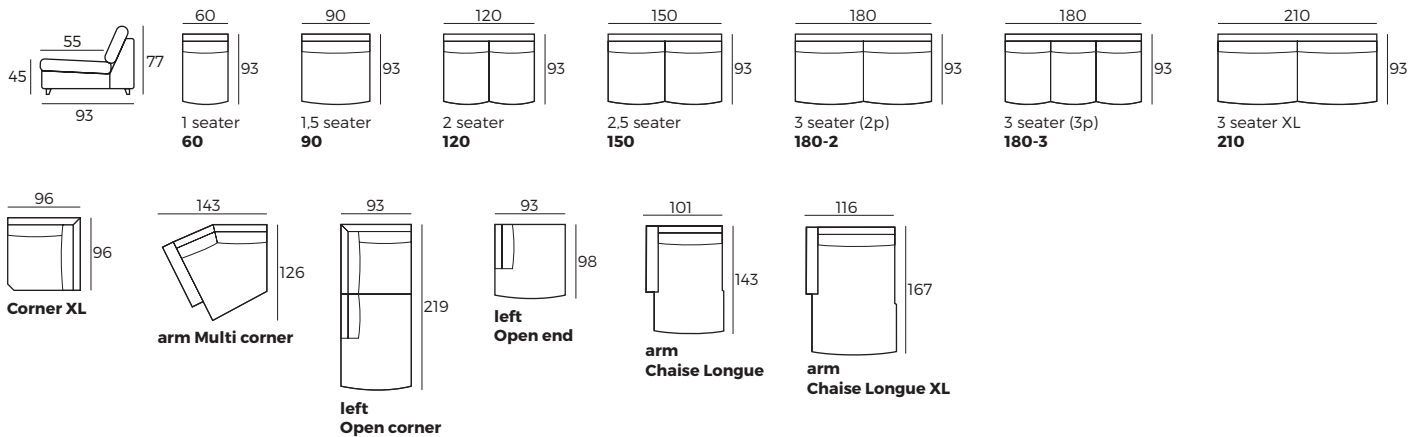

THUJA

Modules with armrest

Scale 1:100

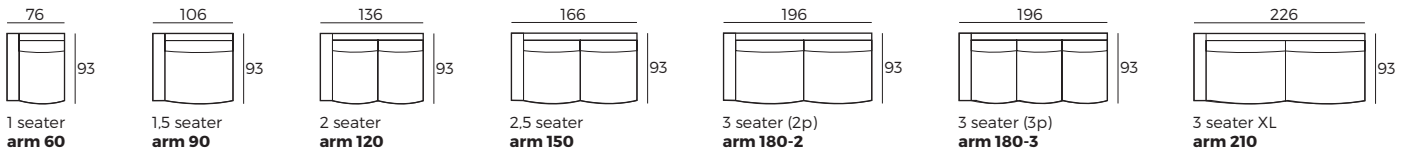

Combinations

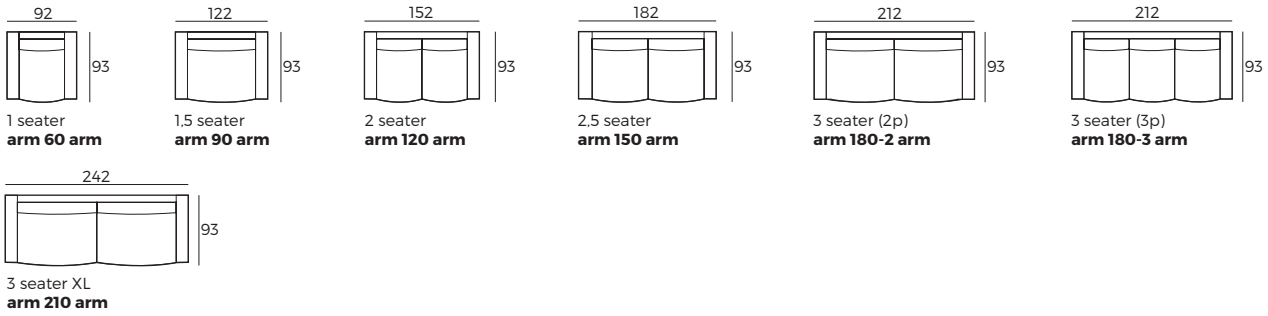

Accessories

